



Conductivity Switch

LRS 1-50

EN
English

Original Installation Instructions
819223-02

Contents

Page

Important notes

Usage for the intended purpose.....	4
Function.....	4
Safety note.....	5

Directives and standards

EU Pressure Equipment Directive 2014/68/EU.....	6
VdTÜV Bulletin "Water Monitoring 100".....	6
LV (Low Voltage) Directive and EMC (Electromagnetic Compatibility).....	6
ATEX (Atmosphère Explosible).....	6
Note on the Declaration of Conformity / Declaration by the Manufacturer CE	6

Technical data

LRS 1-50.....	7
Scope of supply.....	8
Name plate / marking.....	8

In control cabinet: Mounting the conductivity switch

Dimensions LRS 1-50.....	9
Key.....	9
Installation in control cabinet.....	9

In control cabinet: Wiring the conductivity switch

Wiring diagram for conductivity switch LRS 1-50.....	10
Key.....	10
Connection of supply voltage.....	11
Connecting output contacts.....	11
Connecting conductivity electrode LRG 12-2, LRG 16-4, LRG 17-1 and LRG 19-1, resistance thermometer TRG 5-.....	11
Connection of conductivity electrode LRG16-9.....	11
Attention.....	11

In the plant:

Wiring the conductivity electrode

Connecting conductivity electrode LRG 12-2, LRG 16-4, LRG 17-1 and LRG 19-1, resistance thermometer TRG 5-.....	12
Connection of conductivity electrode LRG16-9.....	12

Contents - continued -

Page

Factory setting	13
------------------------------	----

Changing factory settings

Switch selection of unit of measurement	13
---	----

Operating the conductivity switch

Key to codes on seven-segment display	14
---	----

Commissioning procedure

Setting parameters	15
Setting switchpoints and parameters	16

Operation, alarm and test

Checking indication and functions of MIN / MAX output contacts	17
--	----

Troubleshooting

Indication, diagnosis and remedy	18
--	----

Further Notes

Action against high frequency interference	19
Decommissioning / replacing the equipment	19
Disposal	19

Important notes

Usage for the intended purpose

The conductivity switch LRS 1-50 in conjunction with conductivity electrodes LRG 1.-. is used as limit switch, for instance in steam boilers, (pressurized) hot-water installations and condensate and feedwater tanks. The conductivity switch detects and indicates a MIN and a MAX conductivity limit.

The conductivity switch LRS 1-50 is designed for use in combination with the following conductivity electrodes: LRG 12-1, LRG 16-4, LRG 16-9, LRG 17-1 and LRG 19-1.

Function

The conductivity switch **LRS 1-50** in conjunction with the conductivity electrode LRG 1.-. measures the electrical conductivity in conductive liquids. The conductivity electrodes LRG 12-2, LRG 16-4, LRG 17-1, LRG 19-1 or the LRG 16-9 with integrated resistance thermometer for detecting the fluid temperature can be used with the conductivity switch. To measure the temperature you can also use a separate resistance thermometer Pt 100.

When connecting the conductivity electrode **LRG 1.-.** a reference measurement is taken and by setting the correction factor **CF** accordingly the conductivity readings are adapted to the specific conditions of the installation

If a resistance thermometer is used, not only the electrical conductivity but also the water temperature will be measured. The conductivity readings can then be referenced to the standard reference temperature of 25 °C and the conductivity value will be automatically compensated for temperature.

For this purpose the water temperature is constantly measured by the conductivity switch and the conductivity reading is automatically compensated as a function of the adjusted temperature coefficient **tC** (%/°C). Even if the temperature changes, thanks to the adjusted linear temperature compensation, the measured value is referenced to 25 °C over the whole measuring range and indicated on the 7-segment LED display.

The MAX /MIN limits can be variably adjusted within the measuring range.

When the MIN or MAX limit is reached, the MIN or MAX output contact is switched over and MIN or MAX LED is illuminated. The equipment will be reset once the value passes outside the preset hysteresis.

Any faults or malfunctions in the conductivity electrode, the electrical connection or the settings will be indicated by the 7-segment LED display. In the event of a malfunction a MIN and MAX alarm will be triggered.

If an error occurs in the conductivity switch LRS 1-50, MIN and MAX alarms are raised and the system is restarted.

Parameter settings can be changed or a MIN/MAX alarm be simulated by operating the rotary button.

The electrical conductivity is measured in $\mu\text{S}/\text{cm}$. In some countries ppm (parts per million) is used instead. Conversion: $1\ \mu\text{S}/\text{cm} = 0.5\ \text{ppm}$. The conductivity switch can be adjusted accordingly.

Important notes - continued -

Safety note

The equipment must only be installed, wired and commissioned by qualified and competent staff. Retrofitting and maintenance work must only be performed by qualified staff who - through adequate training - have achieved a recognised level of competence.



Danger

The terminal strips of the equipment are live during operation. This presents the danger of electric shock!

Always **cut off power supply** to the equipment before mounting, removing or connecting the terminal strips!



Attention

The name plate specifies the technical features of the equipment. Note that any piece of equipment without its specific name plate must neither be commissioned nor operated.

Directives and standards

EU Pressure Equipment Directive 2014/68/EU

The conductivity control & monitoring equipment LRG 1.-..., LRS 1-5..., LRR 1-5.. meets the safety requirements of the Pressure Equipment Directive (PED). The conductivity control & monitoring equipment is EC type approved according to EN 12952/EN 12953. These Directives state, among other things, the requirements made on limiting systems and equipment for steam boiler plants and (pressurised) hotwater installations.

VdTÜV Bulletin "Water Monitoring 100"

The conductivity switch LRS 1-50 in conjunction with the conductivity electrode LRG 1.-.. is type approved according to VdTÜV Bulletin "Water Monitoring 100". The VdTÜV Bulletin "Water Monitoring 100" states the requirements made on water monitoring equipment.

LV (Low Voltage) Directive and EMC (Electromagnetic Compatibility)

The equipment meets the requirements of the Low Voltage Directive 2014/35/EU and the EMC Directive 2014/30/EU.

ATEX (Atmosphère Explosible)

According to the European Directive 2014/34/EU the equipment must **not** be used in explosion risk areas.



Note

The conductivity electrodes LRG 12-1, LRG 16-4, LRG 16-9, LRG 17-1 and LRG 19-1 are simple items of electrical equipment as specified in EN 60079-11 section 5.7. According to the European Directive 2014/34/EU the equipment must be equipped with approved Zener barriers if used in potentially explosive areas. Applicable in Ex zones 1, 2 (1999/92/EC). The equipment does not bear an Ex marking.

Note on the Declaration of Conformity / Declaration by the Manufacturer C€

For details on the conformity of our equipment according to the European Directives see our Declaration of Conformity or our Declaration of Manufacturer.

The current Declaration of Conformity / Declaration of Manufacturer are available in the Internet under www.gestra.com/documents or can be requested from us.

Technical data

LRS 1-50

Supply voltage

24 VDC +/- 20%

Fuse

external 0.5 A (semi-delay)

Power consumption

4 VA

Connection of conductivity electrode

- 1 input for conductivity electrode LRG 12-1, LRG 16-4, LRG 17-1 and LRG 19-1 (cell constant 1 cm⁻¹), 3 poles with screen
- 1 input for conductivity electrode LRG 16-9 (cell constant 0.5 cm⁻¹), with integrated resistance thermometer Pt 100, 5 poles with screen.

Measuring voltage

0.8 V_{ss}, pulse duty factor $t_v = 0.5$, frequency 20-10000 Hz.

Measuring range

1 to 10,000 µS/cm at 25 °C or 1 to 5,000 ppm at 25 °C.

Switching hystereses

MIN limit: + 3 % of the adjusted MIN limit,

MAX limit: - 3 % of the adjusted MAX limit.

Outputs

LRS 1-50: 2 volt-free change-over contacts, 8 A 250 V AC / 30 V DC $\cos \varphi = 1$.

Provide inductive loads with RC combinations according to manufacturer's specification to ensure interference suppression

Indicators and adjusters

- 1 rotary button with integrated push-button for parameter setting and testing MAX /MIN alarm,
- 1 seven-segment LED display, four digits,
- 2 red LEDs for MAX/MIN alarm,
- 1 four-pole code switch for configuration settings

Housing

Housing material: base: polycarbonate, black; front: polycarbonate, grey

Conductor size: 1 x 4.0 mm² solid, per wire, or

1 x 2.5 mm² per stranded wire with sleeve to DIN 46228 or

2 x 1.5 mm² per stranded wire with sleeve to DIN 46228 (min. \varnothing 0.1 mm)

Terminal strips can be detached. Fixing of housing: Mounting clip on supporting rail TH 35, EN 60715

Electrical safety

Pollution degree 2 for installation in control cabinet with protection IP 54, completely insulated

Protection

Housing: IP 40 to EN 60529,

Terminal strip: IP 20 to EN 60529

Weight

approx. 0.2 kg

Ambient temperature

when system is switched on: 0° ... 55 °C, during operation: -10 ... 55 °C

Transport temperature

-20 ... +80 °C (<100 hours), defrosting time of the de-energized equipment before it can be put into operation: 24 hours.

LRS 1-50 - continued -

Storage temperature

-20 ... +70 °C, defrosting time of the de-energized equipment before it can be put into operation: 24 hours.

Relative humidity

max. 95%, no moisture condensation

Approvals:

TÜV certificate

VdTÜV Bulletin "Wasserüberwachung 100" (= Water Monitoring 100):
Requirements made on water monitoring equipment
Type approval: TÜV · WÜL · XX-XXX (see name plate).

Scope of supply

LRS 1-50

- 1 Conductivity switch LRS 1-50
- 1 Adhesive label ppm
- 1 Installation manual

Name plate / marking

Name plate (on top)

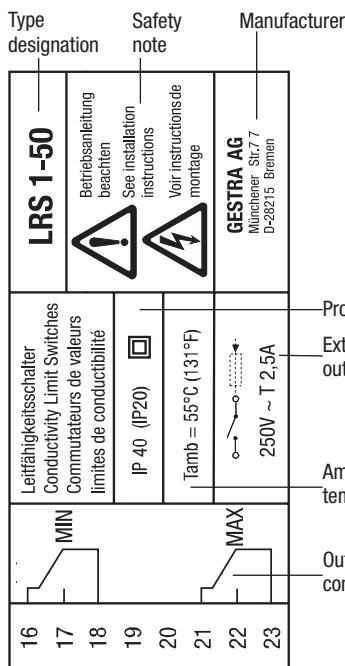

Name plate (at the bottom)

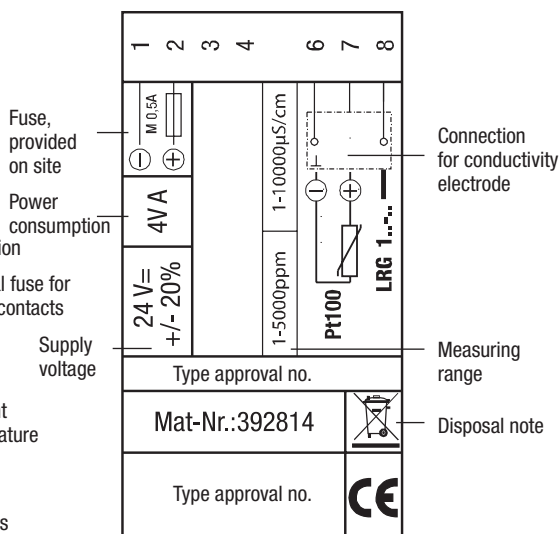

Fig. 1

In control cabinet: Mounting the conductivity switch

Dimensions LRS 1-50

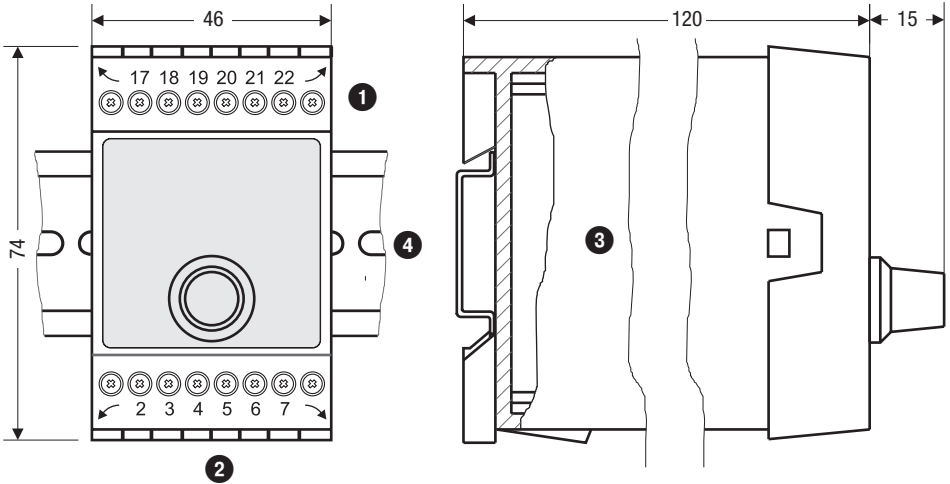

Fig. 2

Key

- | | |
|------------------------|--|
| 1 Upper terminal strip | 3 Housing |
| 2 Lower terminal strip | 4 Supporting rail type TH 35, EN 60715 |

Installation in control cabinet

The conductivity switch LRS 1-50 is clipped onto the support rail type TH 35, EN 60715 in the control cabinet. Fig. 1 4

In control cabinet: Wiring the conductivity switch

Wiring diagram for conductivity switch LRS 1-50

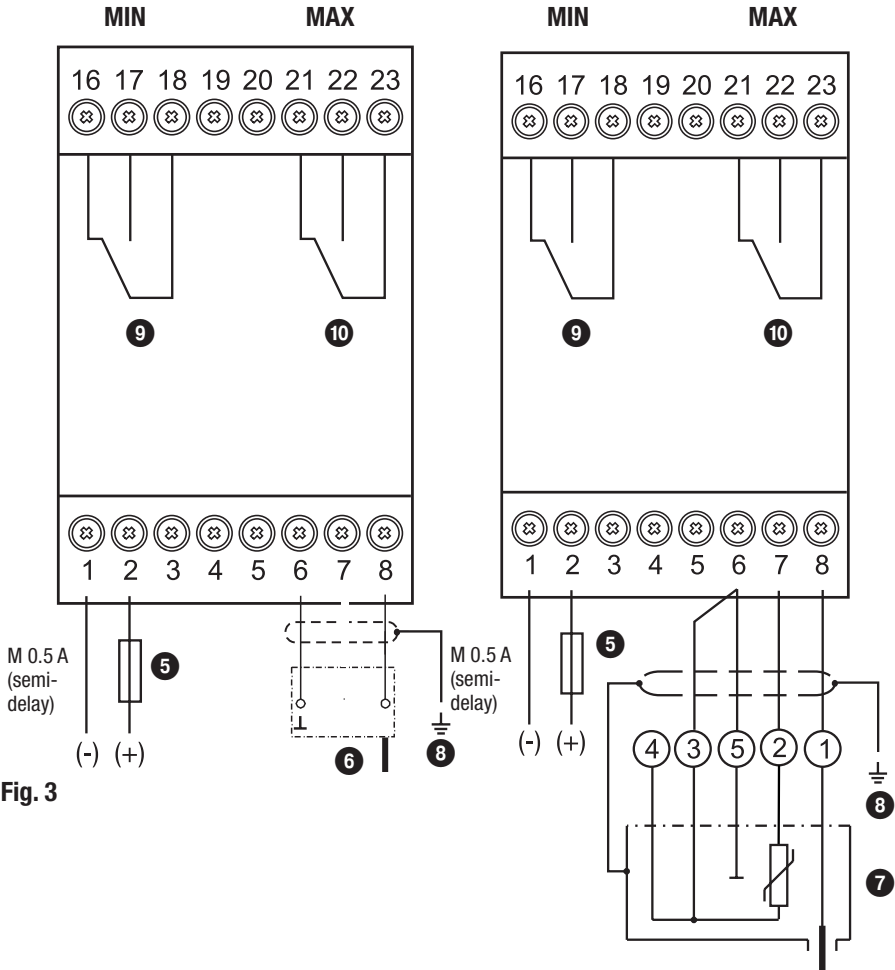

Fig. 3

Key

- 5 Connection of supply voltage **24 V DC** with fuse 0.5 A (semi-delay), provided on site
- 6 Conductivity electrode LRG 1-... (Terminal 6/7: A resistance thermometer can be connected)
- 7 Conductivity electrode LRG 16-9 with integrated resistance thermometer
- 8 Central earthing point (CEP) in control cabinet
- 9 MIN output contact
- 10 MAX output contact

Connection of supply voltage

The equipment is supplied with 24 V DC and fused with an external semi-delay fuse 0.5 A. Please use a safety power supply unit with safe electrical isolation.

The power supply unit must be electrically isolated from dangerous contact voltages and must meet at least the requirements on double or reinforced isolation according to one of the following standards:

DIN EN 50178, DIN EN 61010-1, DIN EN 60730-1 or DIN EN 60950.

Connecting output contacts

Wire the upper terminal strip ❶ (terminals 16-23) according to the desired switching functions. Provide an external slow-blow fuse 2.5 A for the output contacts.

When switching off inductive loads, voltage spikes are produced that may impair the operation of control and measuring systems. Connected inductive loads must be provided with suppressors such as RC combinations as specified by the manufacturer.

When used as conductivity limiter, the conductivity switch LRS 1-50 does not interlock automatically when readings exceed the MAX limit.

If an interlock function is required for the installation it must be provided in the follow-up circuitry (safety circuit). The circuitry must meet the requirements of the EN 50156.

Connecting conductivity electrode LRG 12-2, LRG 16-4, LRG 17-1 and LRG 19-1, resistance thermometer TRG 5-..

To connect the equipment use screened multi-core control cable with a min. conductor size 0.5 mm², e. g. LiYCY 2 x 0.5 mm².

Wire terminal strip in accordance with the wiring diagram. **Fig. 3**

Connect the screen only once to the central earthing point (CEP) in the control cabinet.

Make sure that connecting cables leading to the equipment are segregated and run separately from power cables.

Connection of conductivity electrode LRG16-9

The conductivity electrode LRG 16-9 is equipped with a sensor plug-in connection type M 12, with 5 poles, A-coded, pin assignment see **Fig. 3**. For connecting the equipment preconfigured control cable assemblies (with male and female connectors) of various lengths are available as add-on equipment.

To connect the conductivity switch LRS 1-50 remove the connector and wire the terminal strip according to the wiring diagram. **Fig. 3**.

Connect the screen only once to the central earthing point (CEP) in the control cabinet.

If you do not use the prefabricated control cable assembly, use screened five-core control cable, e. g. LiYCY 5 x 0.5 mm², for connecting the equipment. In addition, connect at the electrode end a screened female connector to the control cable.

Make sure that connecting cables leading to the equipment are segregated and run separately from power cables.



Attention

- Do not use unused terminals as support point terminals.

In the plant: Wiring the conductivity electrode

Connecting conductivity electrode LRG 12-2, LRG 16-4, LRG 17-1 and LRG 19-1, resistance thermometer TRG 5-..

To connect the equipment use screened multi-core control cable with a min. conductor size 0.5 mm², e. g. LiYCY 3 x 0.5 mm².

Wire terminal strip in accordance with the wiring diagram. **Fig. 3**

Connect the screen only once to the central earthing point (CEP) in the control cabinet.

Max. cable length between conductivity electrode / resistance thermometer and conductivity switch: 30 m, with conductivities from 1 to 10 µS/cm: max. 10 m.

Make sure that connecting cables leading to the equipment are segregated and run separately from power cables.

Connection of conductivity electrode LRG16-9

The conductivity electrode LRG 16-9 is equipped with a sensor plug-in connection type M 12, with 5 poles, A-coded, pin assignment see **Fig. 3**. For connecting the equipment preconfigured control cable assemblies (with male and female connectors) of various lengths are available as add-on equipment.

Note that the recommended control cable is not UV-resistant and, if installed outdoors, must be protected by a UV-resistant plastic tube or cable duct.

To connect the conductivity switch LRS 1-50 remove the connector and wire the terminal strip according to the wiring diagram. **Fig. 3**

Connect the screen only once to the central earthing point (CEP) in the control cabinet.

If you do not use the prefabricated control cable assembly, use screened five-core control cable, e. g. LiYCY 5 x 0.5 mm², for connecting the equipment. In addition, connect at the electrode end a screened female connector to the control cable.

Max. cable length between conductivity electrode and switch: 30 m, with conductivities from 1 to 10 µS/cm: max. 10 m.

Make sure that connecting cables leading to the equipment are segregated and run separately from power cables.



Attention

- To commission the equipment please refer to the installation & operating manuals for LRG 12-2, LRG 16-4, LRG 16-9, LRG 17-1, LRG 19-1 and TRG 5-.. .
- Make sure that connecting cables leading to the equipment are segregated and run separately from power cables.
- Check the connection of the screen to the central earthing point (CEP) in the control cabinet.

Tools

- Screwdriver, size 3.5 x 100 mm, completely insulated according to VDE 0680-1.

Factory setting

Conductivity Switch LRS 1-50

- MAX switchpoint AL.Hi = 6000 $\mu\text{S}/\text{cm}$
- MIN switchpoint AL.Lo = 500 $\mu\text{S}/\text{cm}$
- Switching hysteresis: $\pm 3\%$ (fixed setting)
- Correction factor CF: 1
- Temperature compensation inP: No
- Temperature coefficient tC: 2.1 % / $^{\circ}\text{C}$
- **Code switch 11**: All switches are set to OFF.

Changing factory settings



Danger

The upper terminal strip of the equipment is live during operation. This presents the danger of electric shock!

Always cut off power supply to the equipment before mounting, removing or connecting the terminal strips!

Switch selection of unit of measurement

The electrical conductivity is measured in $\mu\text{S}/\text{cm}$. In some countries ppm (parts per million) is used instead. Conversion: 1 $\mu\text{S}/\text{cm}$ = 0.5 ppm. Use the code switch 11 to set the desired unit of measurement. This unit setting is then applicable for all conductivity readings and settings. If you choose ppm as unit of measurement, please stick the adhesive label supplied with the equipment onto the unit specification on the housing.

To change the setting proceed as follows:

- Insert a screwdriver to the right and left of the arrow markings between the terminal strip and the front frame.
- Unlock terminal strip on the left and right side For this purpose move screwdriver in direction of the arrow.
- Remove the terminal strip
- Set switch S4 of code switch 11 to ON = ppm (parts per million)
- Re-attach lower terminal strip.
- Apply supply voltage. Equipment is restarted.

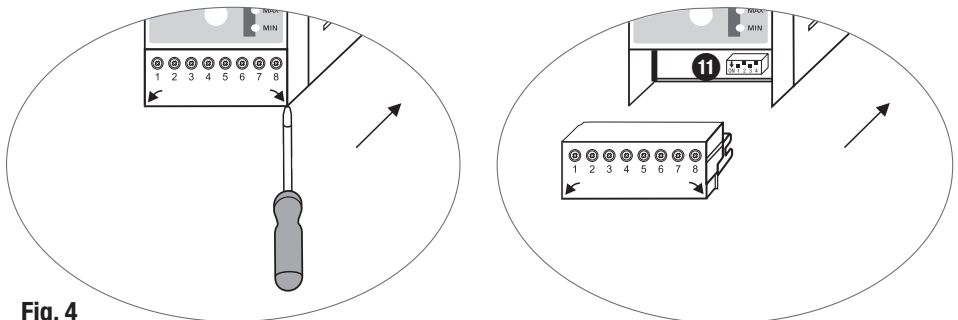

Fig. 4



Attention

Do not change the code switch 11 settings of S1, S2 and S3 .

Operating the conductivity switch

Key to codes on seven-segment display

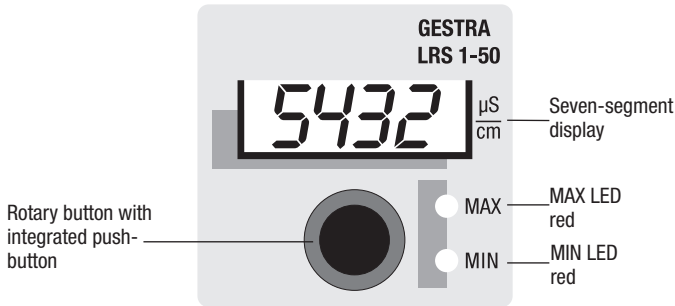

Fig. 5

Code	Description	
Indicated when rotary button is turned to the right:		
AL.Hi	Alarm High	MAX switchpoint
AL.Lo	Alarm Low	MIN switchpoint
CF	Correction Factor	adjustable between 1 and 9999 µS/cm
inP	Input Pt 100	Correction factor, adjustable between 0.05 and 5,000, adjustable in increments of 0.001
tC	Temperature coefficient	Temperature compensation YES (no)
tEst	Test	Temperature coefficient T_k 0.0 – 3.0 % per °C, adjustable in increments of 1 %.
		Tests output relays

Indicated when in parameterization mode:		
quit	Quit	Input not confirmed
done	Done	Input confirmed

Indicated if malfunctions occur:		
E.001	Error	Temperature sensor defective, temperature reading too low
E.002	Error	Temperature sensor defective, temperature reading too high
E.005	Error	Sensor defective, measured value too low
E.006	Error	Sensor defective, measured value too high
E.013	Error	MIN switchpoint above MAX switchpoint

Commissioning procedure

Setting parameters

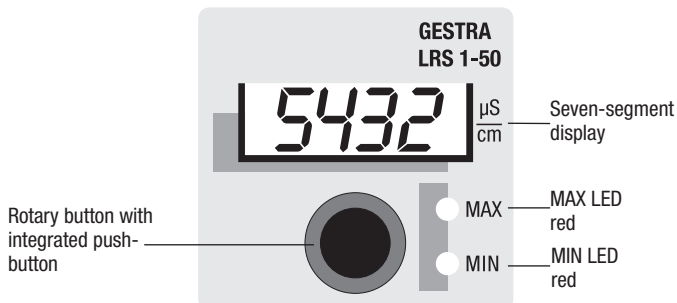

Fig. 5

Start		
Activity	Display	Function
Switch on supply voltage. Water level between MIN and MAX.	Seven-segment display shows equipment and software version.	System test, takes approx. 3 sec.
	Seven-segment display shows actual value	System switches to operating mode

Setting parameters		
Activity	Seven-segment display	Function
Turn rotary button until the desired parameter is indicated.	Display toggles between parameter and the saved value setting.	For selecting the parameter
Press and hold down the push-button (of the rotary button)	First digit (000 <u>0</u>) flashing.	Parameterization mode active. You can change the first digit.
Turn rotary button.	A new value is indicated.	To increase the value turn rotary button to the right, to decrease turn it to the left.
Press push-button. Each time you press the button the system moves to the next digit.	2nd, 3rd or 4th digit is flashing. (from right to left)	2nd, 3rd or 4th digit can be changed by turning the rotary button. To increase the value turn rotary button to the right, to decrease turn it to the left.
<i>If no further operation is performed:</i>	"quit" is indicated for a moment. Then the display toggles between parameter and the old value setting.	The system switches automatically back to parameter and the input is not confirmed.
After the input has been finished: Press and hold down the push-button.	"done" is indicated for a moment. Then the display toggles between parameter and the new value setting.	The input is confirmed and the system switches automatically back to parameter.
Turn rotary button until the next parameter is indicated. Or turn the rotary button until the actual value is shown. If no operation is performed the actual value will be indicated automatically after 30 sec.		

Commissioning

Setting switchpoints and parameters

Setting MIN/MAX switchpoints	
Activity	Function
Select parameter AL.Lo, set the desired conductivity and save the setting.	Adjust MIN limit between 1 and 9999 $\mu\text{S}/\text{cm}$ or 1 and 5000 ppm.
Select parameter AL.Hi, set the desired conductivity and save the setting.	Adjust MAX limit between 1 and 9999 $\mu\text{S}/\text{cm}$ or 1 and 5000 ppm.

Conductivity electrode LRG 1.-...: Setting the correction factor	
Select correction factor CF, set the required value and save the setting.	Once the operating temperature is reached measure the electrical conductivity of a water sample (at 25°C). Set the correction factor (in increments) until the indicated actual value agrees with the reference measured value. As a result the conductivity readings will be adapted to the specific conditions of the installation and any deviations during operation will be compensated for.

Conductivity electrode LRG 1.-... with separate resistance thermometer and LRG 16-9	
Enable temperature compensation	
Select setting inP and turn rotary button to the right. The word "YES" appears. Save the setting.	
Setting the temperature coefficient tC	
Select temperature coefficient tC, set the required percentage value and save the setting.	Once the operating temperature is reached measure the electrical conductivity of a water sample (at 25°C). Set the temperature coefficient (in increments) until the indicated actual value agrees with the reference measured value.
If required: Select correction factor CF, set the required value and save the setting.	During operation the indicated conductivity reading may deviate from the reference value due to e. g. dirt deposits or contamination. Change the correction factor (in increments) until the indicated actual value agrees with the reference measured value.

Operation, alarm and test

Checking indication and functions of MIN / MAX output contacts

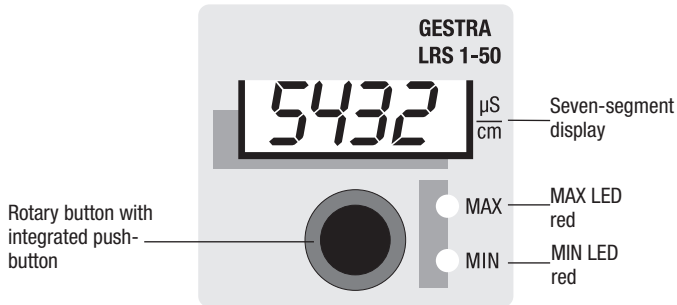

Fig. 5

Operation		
Activity	Display	Function
Conductivity between MIN and MAX.	The actual value is shown on the seven-segment display. MIN and MAX LEDs are not illuminated.	MIN output contact 16/18 open, 17/18 closed. MAX output contact 21/23 open, 22/23 closed.
MIN alarm		
Reading below MIN conductivity limit	MIN LED illuminated red	MIN output contact 16/18 closed, 17/18 open.
MAX alarm		
Switchpoint "MAX conductivity" exceeded.	MAX LED illuminated red	MAX output contact 21/23 closed, 22/23 open.
Testing MIN alarm and MAX alarm		
Activity	Display	Function
During operation: Conductivity between MIN and MAX. Select parameter Test. Press and hold down push-button. Seven-segment display: Test is flashing	MAX LED is illuminated red for 3 sec.	MAX output contact 21/23 closed, 22/23 open.
	MIN and MAX LEDs not illuminated for 1 sec.	MIN output contact 16/18 open, 17/18 open. MAX output contact 21/23 open, 22/23 closed.
	MIN LED is illuminated red for 3 sec.	MIN output contact 16/18 closed, 17/18 open.
Test finished, release push-button. Seven-segment display: Test is indicated.	Note: If you continue to hold down the push-button, a new test is started. You can abort the test any moment by releasing the push-button.	
Turn the rotary button until the actual value is shown. If no operation is performed the actual value will be indicated automatically after 30 sec.		

Troubleshooting

Indication, diagnosis and remedy



Attention

Before carrying out the fault diagnosis please check:

Supply voltage:

Is the equipment supplied with the mains voltage specified on the name plate?

Wiring:

Is the wiring in accordance with the wiring diagram?

Faults indicated by the seven-segment display

Error code	Error	Remedy
E.001	Temperature sensor defective, temperature reading too low	Check resistance thermometer, conductivity electrode LRG 16-9 and, if necessary, replace it with a new one. Check wiring (short circuit, interruption?)
E.002	Temperature sensor defective, temperature reading too high	
E.005	Conductivity electrode defective, measured value too low.	Check conductivity electrode and, if necessary, replace it. Check electrical connection.
E.006	Conductivity electrode defective, measured value too high.	Check conductivity electrode and, if necessary, replace it. Check electrical connection.
E.013	MIN switchpoint above MAX switchpoint	Re-adjust the switchpoints.

In the event of a malfunction a MIN and MAX alarm will be triggered.



Attention

- Please refer to the installation & operating manuals for LRG 12-2, LRG 16-4, LRG 16-9, LRG 17-1, LRG 19-1 and TRG 5-.. for further fault-finding and troubleshooting.



Note

If a malfunction occurs in the conductivity switch, MIN and MAX alarms will be triggered and the equipment is restarted.

Should this happen over and over again, replace the equipment with a new one.

Further Notes

Action against high frequency interference

High frequency interference can occur for example as a result of out-of-phase switching operations. Should such interference occur and lead to sporadic failures, we recommend the following actions in order to suppress any interference.

- Provide inductive loads with RC combinations according to manufacturer's specification to ensure interference suppression.
- Make sure that all connecting cables leading to the conductivity electrode are segregated and run separately from power cables.
- Increase the distance to sources of interference.
- Check the connection of the screen. Check the connection of the screens of the equipment as stipulated in the respective installation & operating manuals. If equipotential bonding currents are to be expected (e. g. in outdoor installations) connect screen only at one end.
- HF interference suppression by means of hinged-shell ferrite rings.

Decommissioning / replacing the equipment

- Switch off supply voltage and **cut off power supply to the equipment.**
- Remove the lower and upper terminal strips **Fig. 6**
 - Insert a screwdriver to the right and left of the arrow markings between the terminal strip and the front frame.
 - Unlock terminal strip on the left and right side For this purpose move screwdriver in direction of the arrow .
 - Remove the terminal strip
- Release the white fixing slide at the bottom of the equipment and take the equipment off the supporting rail.

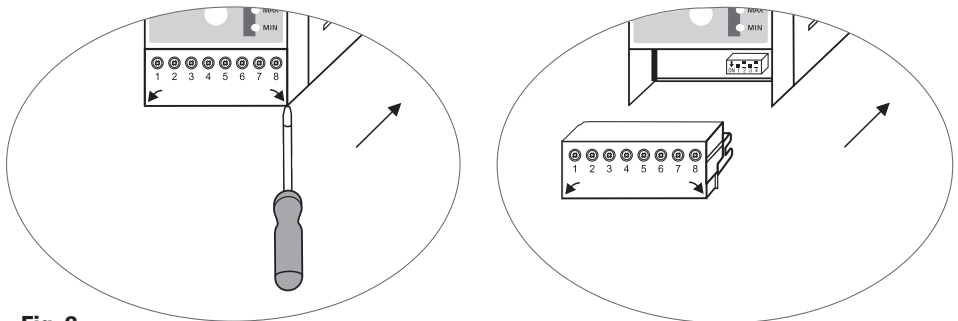

Fig. 6

Disposal

For the disposal of the equipment observe the pertinent legal regulations concerning waste disposal.

If faults occur that are not listed above or cannot be corrected, please contact our service centre or authorized agency in your country.



Agencies all over the world: www.gestra.de

GESTRA AG

Münchener Straße 77

28215 Bremen

Germany

Telefon +49 421 3503-0

Telefax +49 421 3503-393

E-mail info@de.gestra.com

Web www.gestra.de