



Conductivity Switch

LRS 1-7

EN
English

Original Installation Instructions
818872-02

Contents

Page

Important Notes

Usage for the intended purpose	4
Safety Notes	4
Danger	4
LV (Low Voltage) Directive and EMC (Electromagnetic Compatibility)	4
ATEX (Atmosphère Explosible).....	4
Note on the Declaration of Conformity / Declaration by the Manufacturer CE	4

Explanatory Notes

Scope of supply	5
Description	5
Function	5

Technical Data

LRS 1-7	6, 7
Name plate / Marking	8

Dimensions / Functional Elements

LRS 1-7	9
Key	10

Installation

Conductivity switch LRS 1-7	11
-----------------------------------	----

Electrical Connection

Connecting conductivity electrode LRG 16-9.....	11
Attention	11
Connecting conductivity electrode ERL 16, LRG 16-4	11
Connecting conductivity switch LRS 1-7	12
Connecting power output.....	12
Attention	12
Tools.....	12
Wiring diagram for conductivity switch LRS 1-7 (continuous blowdown control).....	13
Wiring diagram for conductivity switch LRS 1-7 (water monitoring).....	14

Contents - continued -

Page

Commissioning

Keys and indicators	15
Checking electrical connection	15
Applying mains voltage.....	15
Factory setting.....	16
Setting parameters	16, 17

Operation

LRS 1-7	18
Note	18

Malfunctions

LRS 1-7	19
Fault finding list for troubleshooting	20, 21

Decommissioning

Danger	22
Exchanging the conductivity switch	22
Disposal.....	22

Important Notes

Usage for the intended purpose

The conductivity switch LRS 1-7 in conjunction with the conductivity electrode LRG 16-9, ERL 16, LRG 16-4 is designed for measuring and monitoring the electrical conductivity in conductive liquids.

Safety note

The equipment must only be installed and commissioned by qualified and competent staff. Retrofitting and maintenance work must only be performed by qualified staff who – through adequate training – have achieved a recognised level of competence.



Danger

The terminal strips of the conductivity switch LRS 1-7 are live during operation. This presents the risk of severe cases of electric shock!
Always **cut off power supply** to the equipment before mounting, removing or connecting the terminal strips!

LV (Low Voltage) Directive and EMC (Electromagnetic Compatibility)

The equipment meets the requirements of the Low Voltage Directive 2014/35/EU and the EMC Directive 2014/30/EU.

ATEX (Atmosphere Explosible)

According to the European Directive 2014/34/EU the equipment must **not** be used in potentially explosive areas.

Note on the Declaration of Conformity / Declaration by the Manufacturer **CE**

For details on the conformity of our equipment according to the European Directives see our Declaration of Conformity or our Declaration of Manufacturer.

The current Declaration of Conformity / Declaration of Manufacturer are available in the Internet under www.gestra.de/documents or can be requested from us.

Explanatory Notes

Scope of supply

LRS 1-7

- 1 Conductivity switch LRS 1-7
- 1 Adhesive plate ppm
- 1 Installation manual

Description

The conductivity switch LRS 1-7 in conjunction with the conductivity electrode LRG 16-9 constitutes a conductivity monitoring and control system. The electrical conductivity of

- Condensate,
- Boiler feedwater,
- Cooling and cleaning water,
- Boiler water

is monitored. In steam boiler plants the conductivity monitoring & control system is used as limit switch and continuous blowdown controller.

Function

The conductivity switch LRS 1-7 in conjunction with the conductivity electrode LRG 16-9, ERL 16, LRG 16-4 measures and monitors the electrical conductivity in conductive liquids. The conductivity switch is designed for the connection of a conductivity electrode with a cell constant of 0.5 cm^{-1} . The integrated resistance thermometer enables the conductivity electrode LRG 16-9 to measure the fluid temperature.

The electrical conductivity changes as the water temperature changes. To obtain readings that can be used for comparison the measurement must be based on a standard reference temperature of $25 \text{ }^\circ\text{C}$.

The water temperature is measured and the conductivity reading is automatically compensated as a function of the adjusted temperature coefficient T_k ($\%/^\circ\text{C}$). If the temperature changes the measured value will be linearly based on $25 \text{ }^\circ\text{C}$ over the whole measuring range thanks to the temperature compensation.

An adjustable contact triggers a signal when the MAX limit is reached.

A two-point controller is integrated in the conductivity switch so that the equipment can also be used in steam boiler installations. The two-point controller controls a continuous blowdown valve and automatically closes it when the boiler is shut down.

In addition the valve can be opened and closed at certain intervals (purging pulses). This prevents the continuous blowdown valve from getting stuck.

A current signal of 4 - 20 mA is available for external processing. The current signal is proportional to the conductivity reading (as a function of the adjusted measuring range).

A short circuit or wire breakage in the conductivity electrode will trigger an error message in the conductivity switch.

The electrical conductivity is measured in $\mu\text{S}/\text{cm}$. In some countries parts per million (ppm) is used instead. Conversion $1 \mu\text{S}/\text{cm} = 0.5 \text{ ppm}$. The conductivity switch can be adjusted accordingly.

Technical Data

LRS 1-7

Type approval

TÜV.WÜL.xx-014

Supply voltage

230 V, +10 / -15 %, 50-60 Hz

115 V, +10 / -15 %, 50-60 Hz (option)

Input

1 Input for conductivity electrode LRG 16-9 (with cell constant 0.5 cm⁻¹)

Output

2 volt-free relay contacts,

max. contact rating for switching voltages 115 V AC and 230 V AC: resistive / inductive 4 A.

Provide contactor with interference suppressor (RC combination).

Contact material: AgNi 0,15.

1 Current output 4-20 mA as actual value output, max. load 500 Ω

Measuring range

0.5 up to 10000 µS/cm at 25 °C or 0.25 up to 5000 ppm at 25 °C

Setpoint W

adjustable between 0.5 and 9999 µS/cm or 0.25 up to 5000 ppm

Limit MAX

adjustable between 0.5 and 9999 µS/cm or 0.25 up to 5000 ppm

Correction factor

adjustable between 0.05 and 5000, adjustable in increments of 0.001

Temperature coefficient T_k

0.0 – 3.0 % per °C, adjustable in increments of 0.1

Actual value output (option)

0.5 mA in the event of failure (E.01-E.04, at the end of the start phase)

4 mA corresponds to 0.5 µS/cm

20 mA corresponds to 10, 200, 500, 1000, 6000, 9999 µS/cm, final values adjustable

Purging interval (continuous blowdown valve is forced to open)

adjustable between 1 h and 24 h in increments of 1 h.

Duration of purging

adjustable between 1 min. and 6 min. in increments of 1 min.

Switching hysteresis

Controller output: – 10 % of the adjusted setpoint W,

Limit MAX: – 3 % of the adjusted MAX limit

Cycle of measurement

1 sec.

Time constant T

Temperature: 20 sec.

LRS 1-7 - continued -

Conductivity: 28 sec.

Indicators and adjustors

1 four-digit, seven-segment indicator, red, for indicating the actual value (X) / setpoint (W) and for status and error messages

2 amber LEDs for indicating actual value / setpoint

1 red LED for indicating MAX limit

2 green LEDs for indicating valve OPEN / CLOSED

4 pushbuttons for value and parameter settings

Power consumption

6 VA

Fuse

external 63 mA, slow blow, at 230 V,

external 125 mA, slow blow, at 115 V

Protection

IP 65 to DIN EN 60529

Protection class

2 (totally insulated)

Ambient temperature

Max. 70 °C

Housing

Housing material: Polycarbonate

Cable entry / Wiring

Cable gland with integral cable clamp, 3 x M 16 x 1.5

1 four-pole screw-type terminal strip for power supply,

1 three-pole screw-type terminal strip for connecting the continuous blowdown valve,

1 three-pole screw-type terminal strip for MAX limit,

1 two-pole screw-type terminal strip for current output 4-20 mA,

Terminal strips detachable, conductor size: 1.5 mm²

1 Sensor jack M12, with 5 poles, A coded, for connecting the conductivity electrode

Cable length

max. 30 m, with conductivities from 0.5 to 10 µS/cm: max. 10 m

Weight

Approx. 0.8 kg

Name plate / Marking





	 			
	<p>Vor Öffnen des Deckels, Gerät freischalten! Betriebsanleitung beachten!</p> <p>Before removing cover, isolate from power supplies. See installation instructions!</p> <p>Avant d'ouvrir le couvercle déconnecter complètement l'appareil. Voir instructions de montage.</p>			Safety note
	LRS 1-7			Equipment designation
	Leitfähigkeitsschalter Conductivity Limit Switches Commutateurs de valeurs limites de conductibilité			
Admissible ambient temperature	Tamb = 70°C (158 °F)			
	230VAC	50/60 Hz	6VA	Power rating
		IP65		Protection
Measuring range	0,25-5000ppm	0,5-10000µS/cm		
	 250 V ~ T 2,0 A			Electrical specification
	TÜV . WÜL . xx - 014			Disposal note
Manufacturer	GESTRA AG Münchener Str. 77 D-28215 Bremen			
	VS.-Nr.:	Mat.-Nr.:		

Fig. 1

Dimensions / Functional Elements

LRS 1-7

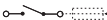
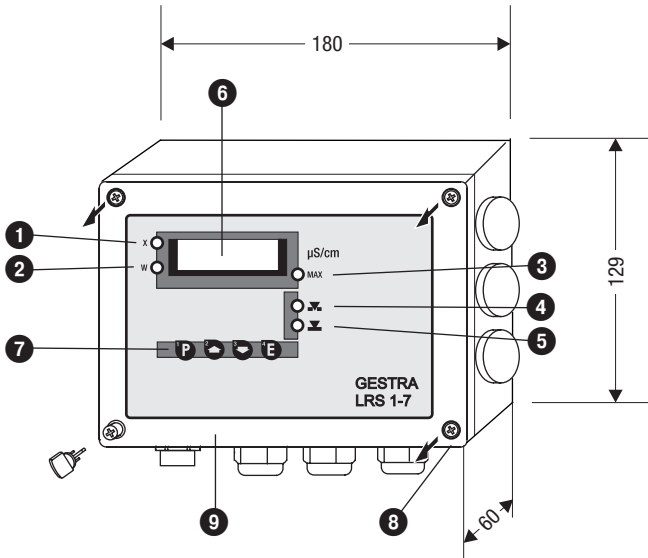

Fig. 2

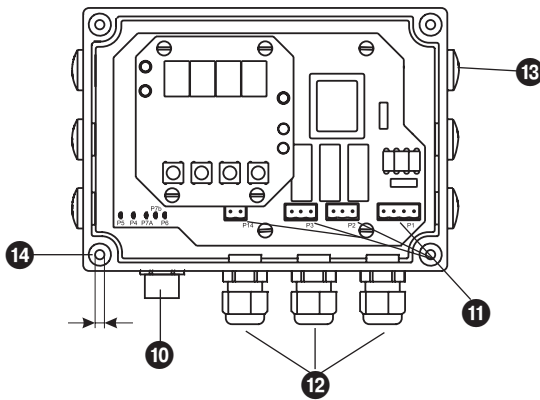

Fig. 3

Dimensions / Functional Elements - continued -

Key

- 1 LED 1: The actual value is shown on the seven-segment display
- 2 LED 2: The setpoint is shown on the seven-segment display
- 3 LED 3: MAX limit reached
- 4 LED 4: The continuous blowdown valve opens
- 5 LED 5: Continuous blowdown valve in operating position
- 6 Seven-segment display, indication of actual value or setpoint, temperature, error code
- 7 Pushbuttons
- 8 Cover screws (cross recess head screws M4)
- 9 Housing cover
- 10 M 12 sensor jack, 5 poles, A coded
- 11 Terminal strips
- 12 Cable glands 3 x M 16 x 1.5
- 13 Sealing plug
- 14 Fixing hole \varnothing 4.5 mm

Installation

Conductivity switch LRS 1-7

The housing of the conductivity switch LRS 1-7 is designed for wall mounting. To access the four fixing holes loosen the cover screws ⑧ and remove the housing cover ⑨. Attach the lower part of the housing by means of suitable screws and wall plugs.

Electrical Connection

Connecting conductivity electrode LRG 16-9

The conductivity electrode LRG 16-9 and the conductivity switch LRS 1-7 are equipped with M 12 sensor connectors with 5 poles and A coded; for connection see **Fig. 4 and Fig. 5**. For connecting the equipment control cable assemblies (with male and female connectors) of various lengths are available as add-on equipment.

Note that the recommended control cable is not UV-resistant and, if installed outdoors, must be protected by a UV-resistant plastic tube or cable duct.

If the above-mentioned control cable assembly is not used, a screened five-core control cable, e. g. Ölflex 110 CH, manufactured by Lapp, 5 x 0.5 mm² or LiYCY 5 x 0.5 mm².

Max. cable length between conductivity electrode and switch: 30 m, with conductivities from 0.5 to 10 µS/cm: max. 10 m.



Attention

- If the above-mentioned control cable assembly is not used, the connecting line must be provided with a connector and a screened jack according to the wiring diagram **Fig. 4**.
- If you do not use the control cable assembly, make sure that the connecting cable used for the installation meets the requirements of protection IP 65.
- Connect screen **only** into the female connector (in electrode)

Connecting conductivity electrode ERL 16, LRG 16-4

Please note:

- If GESTRA conductivity electrodes ERL 16, LRG 16-4 are used connect the control cable assembly to the electrode connector.
- Connect the screen in the connector of the conductivity electrode, see wiring diagram **Fig. 4 and Fig. 5**.
- Set parameter 4. Pt 100 to OFF.

Connecting power output

Any item of equipment that you want to connect to terminals 1 and 2 power output 4-20 mA must be certified to have at least double or reinforced isolation according to DIN EN 50178 or DIN 61010-1 or DIN EN 60730-1 or DIN EN 60950 between the current loop and live parts of the equipment that are not supplied with safety extra-low voltage (SELV).

Connecting conductivity switch LRS 1-7

1. Undo cover screws **8** and remove the housing cover **9**. (Fig. 2, 3)
2. Detach terminal strips **11** from electronic circuit board.
3. Strip off approx. 40 mm of cable insulation coating and remove approx. 5 mm of conductor end insulation.
4. Undo cable glands **12**. Pull mains cable through the right cable gland and the control cables through the other cable glands. Seal off any unused cable glands (protection IP 65). Any additional cable glands used must meet the requirements of protection IP 65.
5. Connect mains and control cables according to the wiring diagram (inside of housing lid) to the terminal strips **11**.
6. Attach terminal strips **11** to electronic circuit board.
7. Replace housing lid **9** and fasten the cover screws **8**.
8. Plug connector of the connecting cable for the conductivity electrode into the jack **10** and fasten it by turning the knurled nut.
9. Plug jack of the connecting line into the connector **14** (conductivity electrode) and fasten it by turning the knurled nut.



Attention

- Mains and control cables with basic insulation must not be located in areas of extra-low voltage.
- Provide conductivity switch with fuse, see Technical Data:
- Provide control circuit with a slow-blow fuse 2.0 A.
- Provide connected contactors with RC combinations according to manufacturer's specification to ensure interference suppression.
- Install an easily accessible all-pole disconnecter near the conductivity switch to ensure electrical separation of the equipment (EN 61010-1).
- Mark the disconnecter as disconnecting device for the conductivity switch.

Tools

- Screwdriver for cross recess head screws, size 1 and 2.
- Screwdriver for slotted screws, size 2.5, completely insulated according to VDE 0680.

Wiring diagram for conductivity switch LRS 1-7 (continuous blowdown control)

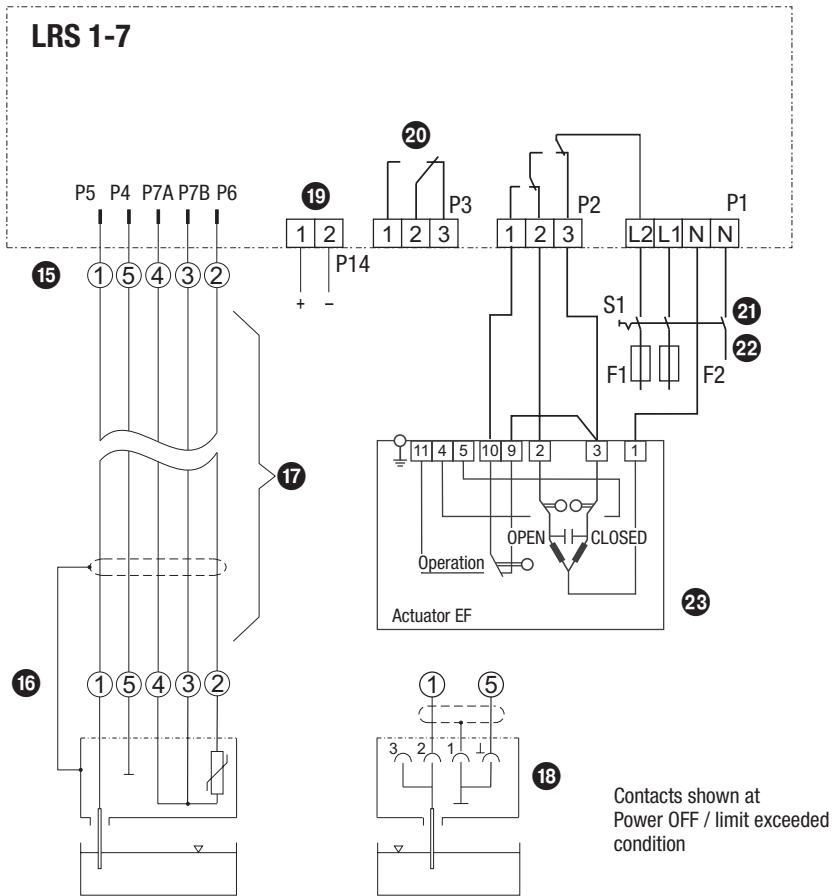

Fig. 4

- 15 Conductivity switch with assignment of M 12 sensor connector (female)
- 16 Conductivity electrode LRG 16-9 with assignment of M 12 sensor connector (male)
- 17 Connecting line
- 18 Conductivity electrode ERL 16, LRG 16-4 (without Pt 100)
- 19 Current output 4-20 mA, load max. 500 Ω
- 20 Limit contact MAX
- 21 S1 Disconnector
- 22 F1 Fuse (output contact)
F2 Fuse (conductivity switch)
- 23 Actuator EF

L2 must remain live after the burner (stand-by operation) is shut down until the continuous blowdown valve is motored to close. L1 and L2 must be connected to an external conductor of the same phase.

Wiring diagram for conductivity switch LRS 1-7 (water monitoring)

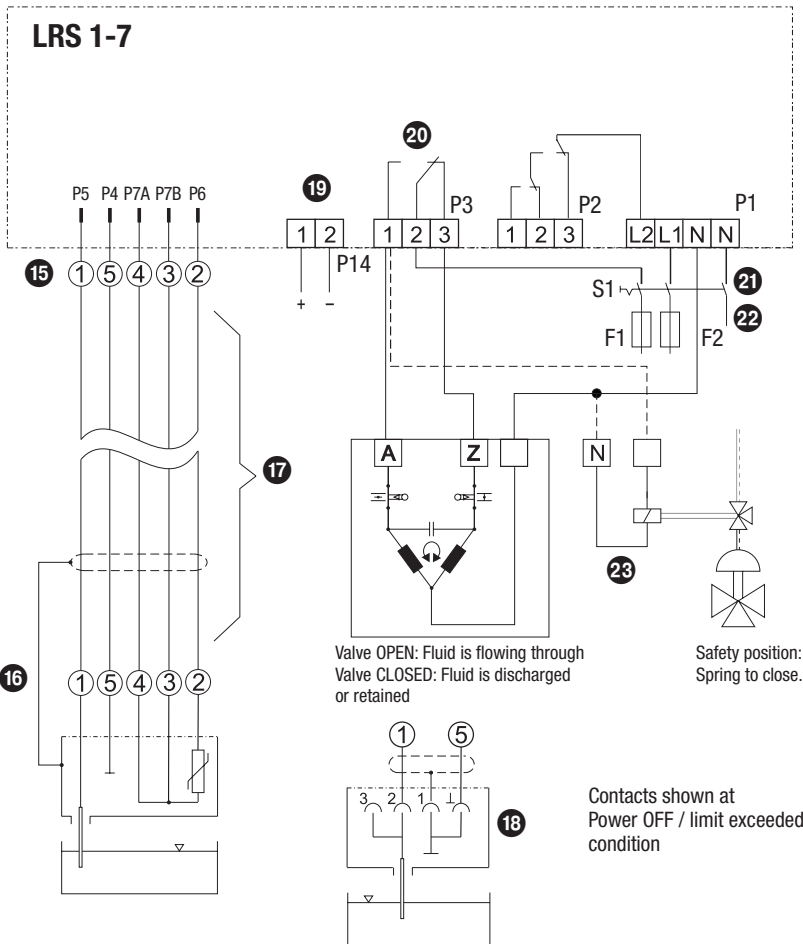
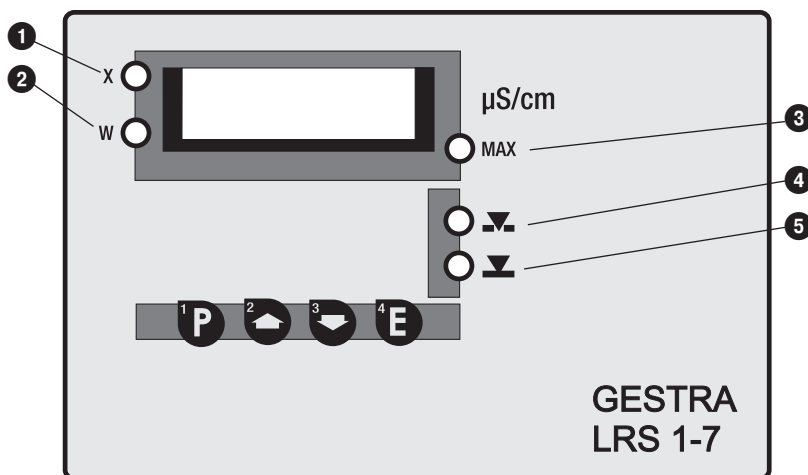

Fig. 5

- 15** Conductivity switch with assignment of M 12 sensor connector (female)
- 16** Conductivity electrode LRG 16-9 with assignment of M 12 sensor connector (male)
- 17** Connecting line
- 18** Conductivity electrode ERL 16, LRG 16-4 (without Pt 100)
- 19** Current output 4-20 mA, load max. 500 Ω
- 20** Limit contact MAX
- 21** S1 Disconnector
- 22** F1 Fuse (output contact)
F2 Fuse (conductivity switch)
- 23** Electric or pneumatic three-way valve

Commissioning

Keys and indicators



Functions of the pushbuttons

Pushbutton 1 (P): Switches to parameterisation mode

Pushbutton 2: Increases value \uparrow , scrolls up

Pushbutton 3: Decreases value \downarrow , scrolls down

Pushbutton 4 (E): Switches back to input mode and saves settings.

Seven-segment display

Indicates actual value or setpoint, temperature, error code

LEDs 1 – 5

LED 1: The actual value X is shown on the seven-segment display

LED 2: The setpoint W is shown on the seven-segment display

LED 3: MAX limit reached

LED 4: Continuous blowdown valve opens

LED 5: Continuous blowdown valve in operating position

Checking electrical connection

1. Make sure that the conductivity switch is wired as specified in the wiring diagram.
2. Make sure that the supply voltage agrees with the specification on the name plate.

Applying mains voltage

Apply mains voltage. First the type designation and the software version are briefly shown on the seven-segment display, then the actual value will be indicated. The continuous blowdown valve is operated and opened for 240 seconds.

Factory setting

The conductivity switch LRS 1-7 features the following factory set default values:

- Setpoint W: 3000 $\mu\text{S}/\text{cm}$
- MAX limit: 5000 $\mu\text{S}/\text{cm}$
- Correction of measured value: 0,5
- PT 100: ON
- Temperature coefficient: 1.3 $\%/^{\circ}\text{C}$
- Unit: $\mu\text{S}/\text{cm}$
- End of measuring range / output of actual value
6000 $\mu\text{S}/\text{cm}$ = 20 mA
- Purging pulse: 24 h, duration of purging: 4 min

Setting parameters

Press button **P** to enter the parameterisation mode. After setting the parameters press button **P** to return to the default operating mode (indication of actual value). If no input is made within 30 sec. after pressing the button, the equipment switches back to the default operating mode (indication of actual value).

Key	Parameter	Indication	Key	Adjustment range	Key	Indication
→ P ← P	1. Setpoint W	1._SP	→ E ← P	0.5-9999 $\mu\text{S}/\text{cm}$ to change press buttons ▲ ▼	→ E	SAVE return to 1. setpoint
▲ ▼	2. MAX limit	2._AL	→ E ← P	0.5-9999 $\mu\text{S}/\text{cm}$ to change press buttons ▲ ▼	→ E	SAVE return to 2. MAX limit
▲ ▼	3. Correction of measured value	3._CF	→ E ← P	0.050-5.000 to change press buttons ▲ ▼	→ E	SAVE return to 3. correction of measured value
▲ ▼	4. PT 100	4._Pt	→ E ← P	ON / OFF to change press buttons ▲ ▼	→ E	SAVE return to 4. PT 100
▲ ▼	4.1 TK	4.1.tC	→ E ← P	0.0 to 3.0 $\%/^{\circ}\text{C}$ to change press buttons ▲ ▼	→ E	SAVE return to 4.1 TK
▲ ▼	5. Unit	5._dl	→ E ← P	$\mu\text{S}/\text{cm}$ / ppm to change press buttons ▲ ▼	→ E	SAVE return to 5. unit
▲ ▼	6. Standardiza- tion of current output	6._SO	→ E ← P	10-9999 $\mu\text{S}/\text{cm}$ to change press buttons ▲ ▼	→ E	SAVE return to 6. standardization of current output
▲ ▼	7. Purging interval	7._SI	→ E ← P	OFF / 1 to 24 h to change press buttons ▲ ▼	→ E	SAVE return to 7. purging interval
▲ ▼	7.1. Duration of purging	7.1._Sd	→ E ← P	1 to 6 min to change press buttons ▲ ▼	→ E	SAVE return to 7.1. Duration of purging

Setting parameters - continued -

- In the parameter **1. Setpoint** set the switchpoint for the continuous blowdown valve to open. The continuous blowdown valve closes once the conductivity falls below the limit and the adjusted hysteresis.
- In the parameter **2. MAX limit** set the switchpoint for the triggering of an alarm or the operation of a three-way valve.

Correcting the measured value (connected conductivity electrode LRG 16-9 with Pt 100)

- Set parameter **4. PT 100** to ON.
- Once the operating temperature is reached measure the electrical conductivity of a water sample (at 25 °C). In the parameter **4.1 TK** set the temperature coefficient (in increments) until the indicated actual value agrees with the measured value.
- During operation the indicated conductivity reading may deviate from the reference value due to e. g. dirt deposits or contamination. In this case change the correction factor (in steps) in the parameter **3. Correction of measured value** until the indicated actual value agrees with the measured value for water.

Correcting the measured value (connected conductivity electrode type ERL, LRG without Pt 100)

- Set parameter **4. PT 100** to OFF.
- Once the operating temperature is reached measure the electrical conductivity of a water sample (at 25 °C). In this case set the correction factor (in steps) in the parameter **3. Correction of measured value** until the indicated actual value agrees with the measured value for water. The conductivity measuring equipment will now be adapted to the conditions of the installation.

Setting further parameters

- The electrical conductivity is measured in $\mu\text{S}/\text{cm}$. In some countries ppm (parts per million) is used instead. Conversion: $1 \mu\text{S}/\text{cm} = 0.5 \text{ ppm}$. In parameter **5. Unit** you can specify the desired unit of measurement. This unit setting is then applicable for all conductivity readings and settings. If you choose ppm as unit of measurement, please use a waterproof felt-tip pen to write the unit on the housing of the equipment.
- In the parameter **6. Standardization of current output** set the final value (20 mA) to 10, 200, 500, 1000, 6000, 9999 $\mu\text{S}/\text{cm}$ or 5, 100, 250, 500, 3000, 5000 ppm.
- To prevent the continuous blowdown valve from blocking set the **time** for the opening and closing of the continuous valve in the parameter **7. Purging interval**. You can adjust intervals from 1 h to 24 hours in steps of 1 h. If the setting OFF is chosen, the blowdown valve will not be operated. The purging interval will be initialised again whenever the conductivity switch is switched off and on.
- If a purging interval has been activated set the time for the operation of the continuous blowdown valve in the parameter **7.1 Duration of purging**. You can adjust a duration ranging from 1 to 6 minutes in steps of 1 min.
- If you want to quit the parameter setting mode press button **P**. The equipment switches back to the beginning of the menu.
- Press button **E** to save the new values or settings. The word SAVE is indicated for approx. 1 sec. Then the equipment switches back to the beginning of the menu.
- Press button **P** to switch back to the default operating mode (indication of actual value). Or use buttons **▲ ▼** to select another parameter.

Operation

LRS 1-7

Start		
Mains voltage L is applied	Indication of actual value X, LED 1 illuminated, LED 4 flashing	The continuous blowdown valve is operated and opened for 240 seconds.
After 240 sec.: Actual value < setpoint	Indication of actual value X, LEDs 1 and 5 illuminated	The continuous blowdown valve is motored into the OPERATING position.
After 240 sec.: Actual value > setpoint	Indication of actual value X, LEDs 1 and 4 illuminated	The continuous blowdown valve is motored into the OPEN position. Once the conductivity has fallen by -10 % of the setpoint the valve is motored into the OPERATING position.

Operation		
Indicate setpoint W	Press button ▲, LED 2 is illuminated and setpoint W indicated	
Indicate MAX limit	Press button ▼, MAX limit is indicated.	
Indicate water temperature / remaining time of purging interval	Press button E, the indication toggles between the fluid temperature* and the remaining purging interval **	* Indication of fluid temperature if parameter 4. PT 100 is set to ON . ** Indication of remaining time if parameter 7. Purging interval has been activated.
Actual value X < setpoint W	Indication of actual value X, LEDs 1 and 5 illuminated	Continuous blowdown valve in OPERATING position
Actual value X > setpoint W	Indication of actual value X, LEDs 1 and 4 illuminated	The continuous blowdown valve is motored into the OPEN position. Once the conductivity has fallen by -10 % of the setpoint the valve is motored into the OPERATING position.
MAX limit exceeded	Indication of actual value X, LEDs 1, 3 and 4 illuminated	Output contact P 3, 1 / 2 open, 2 / 3 closed. The continuous blowdown valve is motored into the OPEN position.
Burner is switched off (stand-by operation)		The continuous blowdown valve is motored into the CLOSED position.



Note

The continuous blowdown valve is equipped with three limit switches for the positions OPEN, CLOSED and OPERATING. In the adjustable OPERATING position the continuous blowdown valve is somewhat open. A certain amount of boiler blowdown is discharged from the boiler in order to keep the TDS (= total dissolved solids) level below the limit. The amount of boiler blowdown can be ascertained by means of the capacity charts for the continuous blowdown valve. Please observe the installation instructions of the GESTRA continuous blowdown valve.

Malfunctions

LRS 1-7

The following errors will be indicated on the seven-segment display:

Error code	Fault	Remedy
E.01	Connection line to conductivity electrode interrupted. Plug-in connector has come loose.	Check connecting line and fasten plug-in connector by tightening the knurled nut.
E.01	Signal from resistance thermometer Pt 100 corresponds to a temperature of $< 0\text{ }^{\circ}\text{C}$.	Check connecting line. Replace conductivity electrode.
E.02	Signal from resistance thermometer Pt 100 corresponds to a temperature of $> 280\text{ }^{\circ}\text{C}$.	Check connecting line. Replace conductivity electrode.
E.03	Short circuit in conductivity electrode	Check connecting line, replace conductivity electrode.
E.04	Interruption in conductivity electrode	Check connecting line, replace conductivity electrode.

If an error is indicated the LEDs 3 (MAX limit reached) and 5 are illuminated. The continuous blowdown valve is motored into the OPERATING position and the power output reading is 0.5 mA.

Malfunctions - continued -

Fault finding list for troubleshooting

Equipment does not work

Fault: No voltage supply, no function.
Remedy: Check voltage supply and all electrical connections.

Fault: The electronic circuit board is defective.
Remedy: Replace conductivity switch.

Equipment signals a malfunction

Error code: E.01
LED: LEDs 3 and 5 are illuminated.
Fault: Connecting line to conductivity electrode interrupted.
Plug-in connectors have come loose.
Remedy: Check connecting line and fasten plug-in connector by tightening the knurled nut.

Error code: E.01
LED: LEDs 3 and 5 are illuminated.
Fault: Signal from resistance thermometer Pt 100 corresponds to a temperature of $< 0\text{ }^{\circ}\text{C}$.
Remedy: Check connecting line. Replace conductivity electrode.

Error code: E.02
LED: LEDs 3 and 5 are illuminated.
Fault: Signal from resistance thermometer Pt 100 corresponds to a temperature of $> 280\text{ }^{\circ}\text{C}$.
Remedy: Check connecting line. Replace conductivity electrode.

Error code: E.03
LED: LEDs 3 and 5 are illuminated.
Fault: Short circuit in conductivity electrode
Remedy: Check connecting line. Replace conductivity electrode.

Error code: E.04
LED: LEDs 3 and 5 are illuminated.
Fault: Interruption in conductivity electrode.
Remedy: Check connecting line. Replace conductivity electrode.

Malfunctions - continued -

Fault finding list for troubleshooting - continued -

Equipment does not work correctly

Fault: Indicated conductivity reading is larger than the reference value.
Remedy: Change correction factor (3. Correction of measured value) and, if necessary, temperature coefficient (4.1 TK).

Fault: Indicated conductivity reading is smaller than the reference value.
Remedy: Change correction factor (3. Correction of measured value) and, if necessary, temperature coefficient (4.1 TK).

Fault: The measured value cannot be adapted by changing the correction factor or the temperature coefficient.
Remedy: Remove conductivity electrode and clean measuring surface.

Fault: Current output is always 20 mA.
Remedy: Adapt parameter "6. Standardisation of current output" to the conductivity reading.

If faults occur that are not listed above or cannot be corrected, please contact our service centre or authorized agency in your country.

Decommissioning



Danger

The terminal strips of the conductivity switch LRS 1-7 are live during operation. This presents the risk of severe cases of electric shock!
Always **cut off power supply** to the equipment before mounting, removing or connecting the terminal strips!

Exchanging the conductivity switch

1. Switch off mains voltage.
2. Undo cover screws ⑥ and remove the housing cover ⑨. (Fig. 2, 3)
3. Detach mains and control cables from terminal strips ⑪ and pull lines out of the cable glands.
4. Detach connecting line to conductivity electrode.
5. Remove conductivity switch.
6. Install and connect new conductivity switch.
7. Attach connecting line to conductivity electrode.
8. Apply mains voltage.

Disposal

Dismantle the conductivity switch and separate the waste materials, using the material specification as a reference. Electronic component parts such as the circuit board must be disposed of separately! For the disposal of the conductivity switch observe the pertinent legal regulations concerning waste disposal.

For your notes



Agencies all over the world: www.gestra.de

GESTRA AG

Münchener Straße 77

28215 Bremen

Germany

Telefon +49 421 3503-0

Telefax +49 421 3503-393

E-mail info@de.gestra.com

Web www.gestra.de